

Uniclass	L6812		
CI/SfB	(29)	L	(L2)



Intelligent Airtight and Windtight building systems



Product Portfolio

pro clima Intelligent Vapour Control/Airtight Membranes & Accessories

INTERNAL AIRTIGHT PRODUCTS



Other internal products



CONTEGA FC
Vapour resistant window plaster sealing tape



ECO COLL
A natural glue adhesive for the airtight sealing of DB+

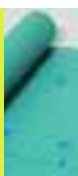

DB+
Cellulose intelligent vapour check and airtight membrane



UNI TAPE
Universal paper based adhesive tape and patches for permanent, airtight and secure bonding

pro clima Intelligent Windtight Diffusion Open Membranes & Accessories

EXTERNAL WINDTIGHT PRODUCTS

SOLITEX PLUS
Vapour permeable windtight roof tile underlay

TESCON PROFIL
Multi-purpose flexible corner sealing tape for windows, doors and corner joints

Other external products



SOLITEX WA
Vapour permeable wall lining membrane

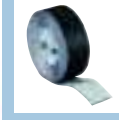

TESCON INVIS
A black tape for use with Solitex WA for concealing taping junctions



TESCON NAIDEC
Nail sealing strip for use under counter battens for increased weather tightness



CONTEGA EXO
Diffusion open sealing tape for outdoor use at window junctions

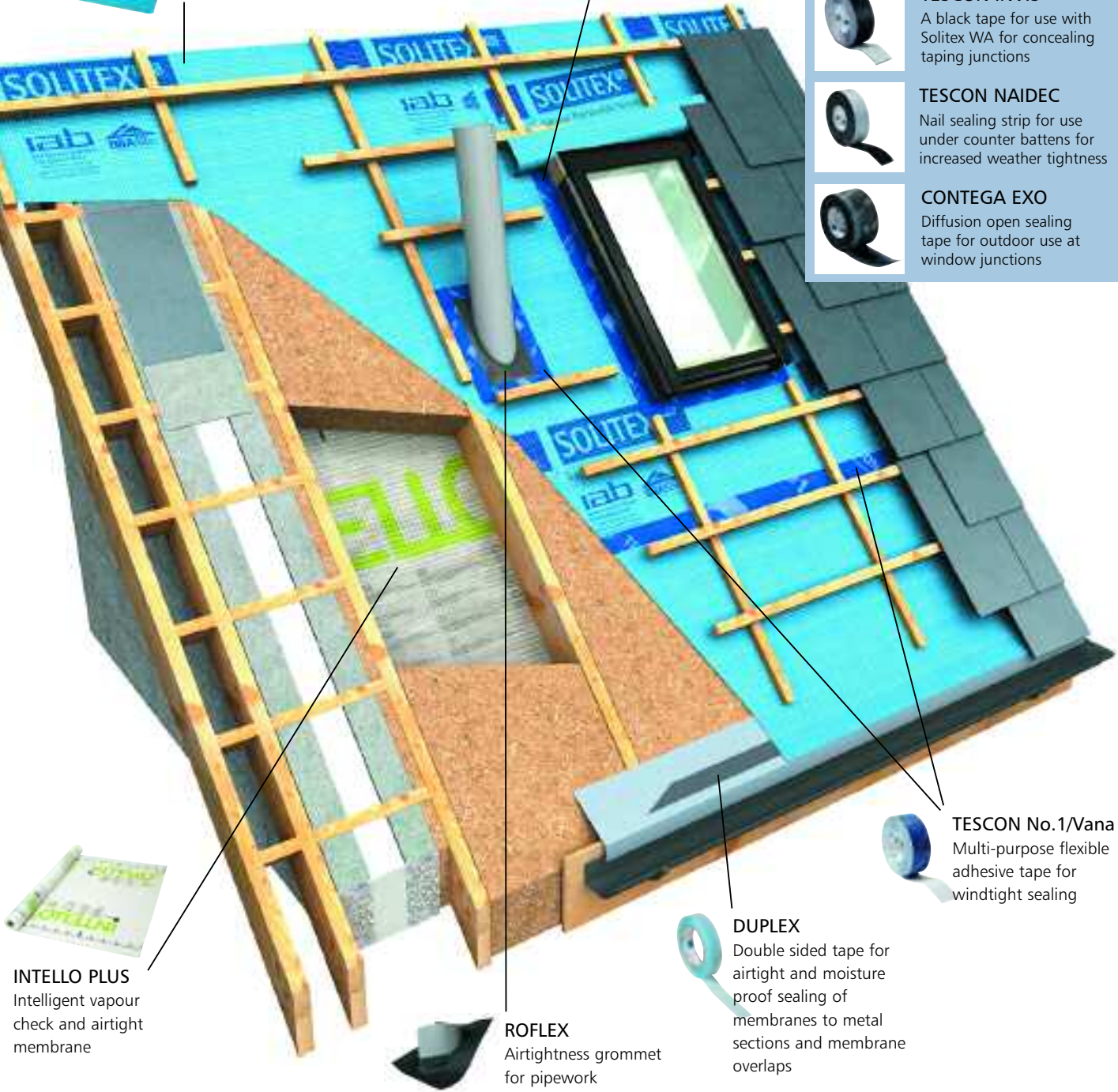

INTELLO PLUS
Intelligent vapour check and airtight membrane

ROFLEX
Airtightness grommet for pipework

DUPLEX
Double sided tape for airtight and moisture proof sealing of membranes to metal sections and membrane overlaps

TESCON No.1/Vana
Multi-purpose flexible adhesive tape for windtight sealing



DA-S
Airtight vapour check sealing strip



KAFLEX
Airtightness grommet for cables and small pipes



DUPLEX
Double sided tape for airtight and moisture proof sealing of membranes to metal sections and membrane overlaps



INSTAA BOX
Creates a local airtight installation zone for plug sockets and light switches



The need for airtightness and windtightness in our buildings:

Research shows that up to half of all heat loss in buildings can be due to air leakage and uncontrolled ventilation. Insulation levels have increased substantially over the last few decades, but heated air is still escaping and can be pinpointed as a major source of energy loss.

We need to act now to reduce our energy consumption; around 50% of carbon emissions are from the built environment with approximately 50% of this energy used for space heating and cooling. The climates of Ireland and the UK do not suffer from extremes in low temperatures, but are exposed to extremes in wind pressure. While insulation is central to low energy construction, air and windtightness must also be central to an energy efficient design strategy to reduce unnecessary heat loss.



More central to all this is living healthily and comfortably. Heat that escapes from buildings carries a significant amount of moisture. This can lead to damage to buildings and building materials, and may have a severe effect on the air quality of the living space. This is why pro clima develop a range of Intelligent diffusion open airtightness solutions to reduce the risk of condensation within structural elements and encourage vapour diffusion.

pro clima have been providing Intelligent airtightness and windtightness solutions for over 2 decades with their products used in some of the most airtight constructions in Ireland, the UK and throughout Europe.



Our pro clima product portfolio shows some key details and products required to build airtight and windtight buildings, reducing the carbon footprint of our built environment and make energy savings, leading to comfortable, healthy, low energy buildings.

The pro clima Intelligent airtight and windtight system is central to the suite of sustainable low energy solutions provided by Ecological Building Systems, putting the health of the homeowner and planet first.



Summary of products and index

General Information

	Page
pro clima and airtightness questions	2-7
Airtightness Installation Guide	20-21
Eco Wall	26
Ecological Building Systems Ltd Information and Contact Details	29-30



Product	Type	Interior	Exterior	
---------	------	----------	----------	--

Membranes - Intelligent airtight vapour checks & windtight vapour permeable membranes

INTELLO PLUS	Intelligent vapour check and airtight membrane	✓		8
DB+	Cellulose Intelligent vapour check and airtight membrane	✓		9
SOLITEX PLUS	Vapour permeable windtight roof tile underlay		✓	22-23
SOLITEX UM connect	Vapour permeable roof lining beneath metal sheet roofing		✓	24
SOLITEX UD connect	Self sealing vapour permeable windtight roof tile underlay		✓	24
SOLITEX WA	Vapour permeable wall lining membrane		✓	25

Tapes and Adhesives

ORCON F	Multi-purpose adhesive	✓	✓	10
ECO COLL	A natural glue adhesive for the airtight sealing of DB+	✓		10
TESCON No. 1	Multi-purpose flexible adhesive tape for airtight sealing	✓	✓	11
UNI TAPE/UNI TAPE Patch	Universal paper based adhesive tape and patches for permanent, airtight and secure bonding	✓		11
TESCON PROFIL	Multi-purpose flexible corner tape for windows, doors and corner joints	✓	✓	12
TESCON INVIS	Black multi-purpose sealing tape	✓	✓	12
DUPLEX	Double sided tape for airtight and moisture proof sealing of membranes to each other and to metal sections	✓	✓	13
TESCON NAIDEC	Double sided butyl rubber nail sealing tape		✓	13
CONTEGA FC	Vapour resistant window plaster sealing tape	✓		14
CONTEGA PV	Vapour resistant masonry junctions sealing tape	✓		14
CONTEGA EXO	Window and door windproof sealing tape		✓	15
DA-S	Airtight vapour check sealing strip	✓		17
TESCON Primer RP	Priming coat suitable for wood fibreboards	✓	✓	18

Pipe and Cable Grommets

INSTAABOX	Airtight installation of service boxes	✓	✓	15
ROFLEX	Airtightness grommet for pipework	✓	✓	16
KAFLEX	Airtightness grommet for cables and small pipes	✓		16

Accessories

WINCON TEST UNIT	Airtightness quality control unit			19
WELLHOFER	Certified pre-insulated airtight attic hatch			27
OPTIME AIRTIGHT DOWNLIGHT PROTECTOR	Sealing system for down lights			28

pro clima

Founded in 1981 pro clima are world innovators of 'Intelligent' airtight membranes. Based in Germany, pro clima leads the field in the development and manufacture of intelligent, high performance sealing systems for thermal insulation in constructions. pro clima engineers and specialists have worked to produce integrated solutions for thermal insulation in timber and masonry constructions and today the company is active in over 20 countries.

pro clima provides complete airtightness and moisture-management systems including intelligent high-performance vapour control membranes, vapour permeable external membranes as well as a complete range of durable glues, tapes and seals.

pro clima products are manufactured according to the highest quality standards of Europe and solely distributed in Ireland and the UK by Ecological Building Systems Ltd, working with a network of stockists.



What is airtightness?

Airtightness is the control of air leakage, i.e., the elimination of unwanted draughts through the external fabric of the building envelope. This may be achieved by the correct and proper installation of a vapour check or vapour barrier. Consequently condensation, mould, rot, damp and structural damage are also eliminated. This ensures a more viable structure, an insulation layer that can perform properly as it is now protected against penetrating moisture reducing the amount of energy-in-use in the building and CO2 emissions. While ventilation is intended, air leakage is not.

It is desirable and necessary to have controlled ventilation for healthy comfortable buildings.

➡ - Potential air leakage paths ➡ - Intended ventilation/openings



Figure 1 A draughty leaky house



Figure 2 A comfortable well sealed, well ventilated house
The key is to **build tight and ventilate right.**

Why build for airtightness?

Sustainable design and construction to achieve low energy, PassivHaus and zero carbon homes are now at the forefront of the building and planning process. Codes and standards are in place which aim to reduce carbon emissions and create homes that are healthier and more sustainable.

The only way to achieve PassivHaus, low carbon and zero carbon building is to ensure a high level of airtightness is attained.

That means designing and installing a continuous seal around the internal fabric of the external envelope to eliminate unwanted draughts. Once the airtight vapour check is in place and sealed with flexible and durable tapes, seals and glues, it ensures that the insulation functions to its optimum performance, saving energy and drastically reducing carbon emissions for the lifetime of the building.

The airtight vapour check also ensures that interstitial condensation risk is minimised, ensuring no structural damage from moisture, mould, rot and damp.

What is an 'Intelligent' Airtight System?

pro clima are innovators and market leaders of an 'Intelligent' airtight system. This differs greatly from conventional vapour barriers and vapour checks.

The technology used in pro clima membranes, **INTELLO PLUS** and **DB+** ensures membranes may become more vapour 'diffusion open' when required. This means that they have the ability to alter their vapour diffusion resistance depending on the average relative humidity surrounding the vapour check. See Figure 3.

In winter the membrane remains diffusion tight (see Figure 4) and will resist the diffusion of vapour from the internal fabric of the building into the insulated layer. However, in summer (see Figure 5) pro clima's membranes, INTELLO PLUS and DB+, may become more vapour open. This allows any moisture which may be trapped in the insulated fabric of the building to back dry to the inside of the house, something a conventional vapour barrier/check cannot do. This ensures a very high level of safety from structural damage due to moisture accumulation over seasonal periods. An Intelligent membrane facilitates significantly more drying compared to a vapour barrier/check.

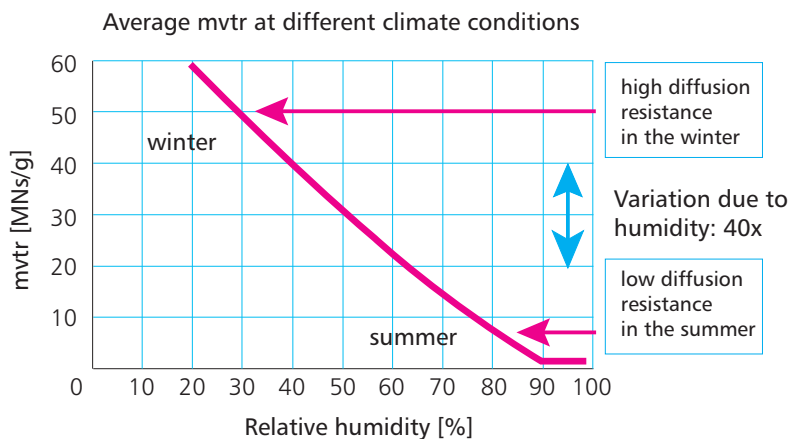

Figure 3
INTELLO PLUS humidity variable vapour diffusion resistance graph

Figure 4
Winter

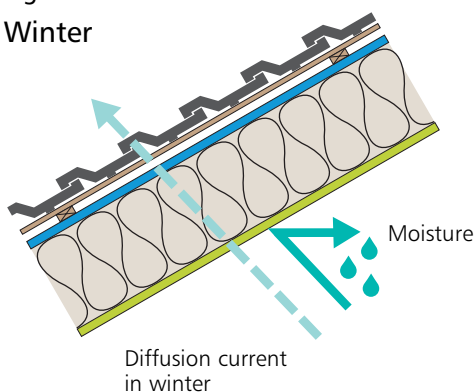
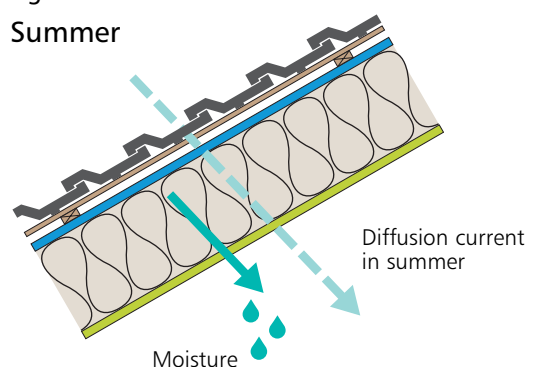

Figure 5
Summer



Why would moisture accumulate within building elements?

Unanticipated moisture may be present in buildings; perhaps as a result of extremely adverse conditions during the building stage (e.g. the timber/insulation gets damp) due to flanking, diffusion directly through the membrane or air leakage (e.g., convection). Using an 'Intelligent' pro clima vapour check ensures that this moisture can dry as quickly as possible due to its unique diffusion properties. Conventional vapour barriers remain vapour tight under all conditions which may lead to damaging moisture build up. The pro clima system offers superior protection against even extreme unforeseen circumstances.

Research shows that under normal winter conditions around 0.5g per sqm per day of moisture is able to penetrate a gap free vapour check/barrier (mvtr 150 MNs/g) by diffusion. See **Figure 6** with a 1mm tear over a 1 square metre area in the vapour check/barrier as much of 800g of moisture can be transferred into the structure per square metre per day by air leakage (convection) – a reduction in performance by 1,600 times!

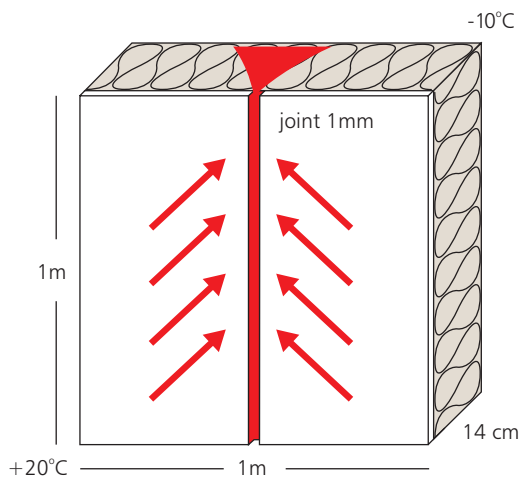

Measurements were taken at an air temperature difference of +20°C (68°F) indoors and -10°C (14°F) outdoors, a pressure difference of 20 Pa (equivalent to wind force 2-3) using conventional, fibrous insulating material.

Such a small tear can reduce the diffusion resistance by a factor of 1600.

Measurement carried out by: Institut für Bauphysik, Stuttgart.

Figure 6



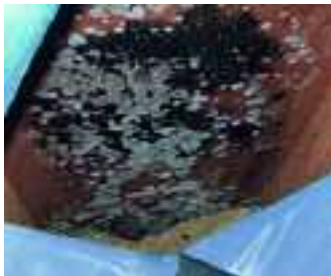

Does this mean a 'Healthier House'?

It is estimated that we spend up to 90% of our life in buildings. Therefore indoor air quality and anything lending itself to reducing risks associated with mould growth is desirable. Mould, rot and fungus may occur as a result of excessive moisture penetration to the fabric of the building. The pro clima system eliminates any potential for this damage due to its ability to allow drying to occur, resulting in a much higher level of air quality in the house and creating a far healthier home and durable building.

Won't an airtight house be a stuffy house?

All buildings have to be ventilated for health and comfort and that's exactly the same for an airtight building.

A suitable ventilation system has to be planned in the design process for every building. The ventilation system will vary depending upon the levels of airtightness to be achieved and the home owners' requirements, from passive ventilation to mechanical ventilation systems for zero carbon and PassivHaus design. **While ventilation is intended, air leakage is not!** The key is to control ventilation and minimise leaks. Of course one can open a window in an airtight house, however, in an airtight house, when the window is closed, no air leakage occurs around the window frame or sill.

The key is to **Build Tight - Ventilate Right.**

Is it difficult and costly to install for airtightness?

Achieving an airtight seal isn't difficult, but it does need to be designed and planned, and attention to detail given on site - it's all about thinking two steps ahead in order to ensure overlaps and joints are effectively sealed. **Take a look at our installation guide on pages 20-21 of the brochure for more information and view our airtight installation video on our website www.ecologicalbuildingsystems.com**

Short cuts and poor workmanship result in air leakage which if detected at the Blower Door testing stage are difficult to rectify. An 'out of sight, out of mind' attitude leads to leaky building. Forethought and monitoring with intermediate assessments through the build process by the use of the pro clima Wincon quality control unit to detect air leakage, minimises and mitigates the need for any costly remediation work. We estimate that the material cost of installing the pro clima airtight system is as little as 0.5% of the total build cost on an average build. The primary cost is related to labour, hence forethought and good design can significantly reduce costs. And then think of the energy saved for the life of the building and you also have a healthy building



pro clima products have been tested and approved by the Sentinel-Haus® Institute to meet their stringent standards for healthy buildings with good quality indoor air



Will installing for airtightness save energy and reduce heating bills?

Research shows that we can lose as much as half of all the energy used to heat our buildings through unwanted draughts, inefficient and poor ventilation. We now generally insulate new houses very well but the proportion of energy lost to draughts has increased and in some cases around half of all heat losses are due to air leakage across the building fabric. In Ireland and the UK we are not exposed to extremes in low temperatures, however our climate is exposed to high wind pressure, particularly in coastal regions.

If a vapour check has as little as a 1mm tear within a square metre area, the U value can reduce by a factor of 4.8 (See Figure 7.)! This means that the calculated U value is not achieved if the structure is not airtight and hence you need a lot more energy to heat the house.

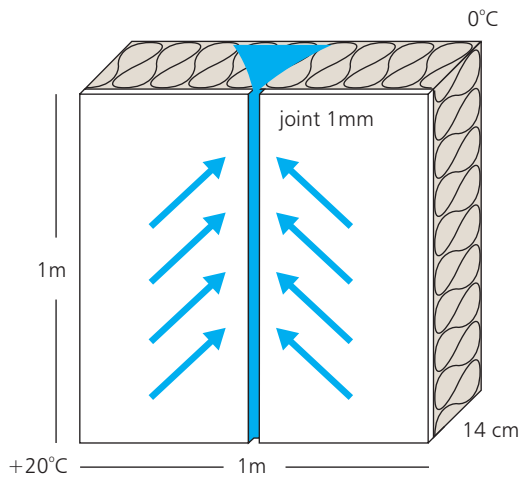

Figure 7

Airtightness does not generally increase U values, but ensures the calculated U value is achieved.

Measurements were taken at an air temperature difference of +20°C (68°F) indoors and -10°C (14°F) outdoors, a pressure difference of 20 Pa (equivalent to wind force 2-3) using conventional, fibrous insulating material.

U-value with airtight vapour barrier = 0.30 W/m²K

U-value with 1mm gap in vapour barrier = 1.44 W/m²K

A gap as small as 1mm in the vapour barrier can reduce the U-Value by a factor of 4.8

Measurement carried out by: Institut für Bauphysik, Stuttgart.

An airtightness layer protecting the insulation is just like wearing a wind shield jacket over our woolly jumper, it ensures that the insulation works to its full potential see Figure 8.

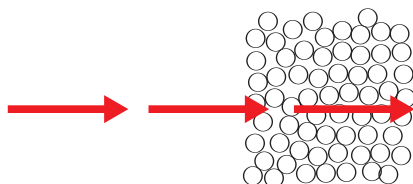

If air moves within insulation it substantially effects the thermal performance.

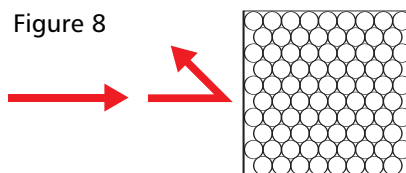

Now it is protected the insulation works to its optimum thermal performance

How do I measure airtightness and what level of airtightness should I aim to achieve?

The most commonly used unit of measurement for airtightness in Ireland and the UK is referred to as the *air permeability* of a building or Q50.

To measure air permeability a pressure differential is induced onto a building using a large fan called a Blower Door. An airtightness measurement usually involves a combination of depressurising and pressurising a building to a pressure difference of 50 Pascal's (50Pa) which is equivalent to a wind speed of about 20 miles per hour on every side of the building envelope at once, by no means an extreme pressure. Once the pressure differential reaches 50 Pa, air leakage may easily be located in the external envelope and an accurate measurement of the air permeability of the external envelope of the building is taken. The air permeability of a building at a pressure differential of 50Pa is referred to as the Q50 of a building and is measured in m³/hr (of airflow) per m² (of total external envelope area).

The standard upper limit level of airtightness in buildings in Ireland and the UK at the time of print, is a Q50 of less than 10m³/hr/m² for all new buildings. Please refer to latest edition of the building regulations for further information. A Q50 of less than 10m³/hr/m² refers to an air permeability of less than 10m³ of air per hour per m² of the external envelope of a building when the building is exposed to a pressure differential by depressurisation and/or pressurisation of 50 Pa. This literally means that when we exclude ventilation and design openings, and exert a pressure difference of 50Pa on the external envelope of the building 10m³ of air per hour passes through every square metre of the external envelope.

According to the Airtightness Testing and Measurement Association (ATTMA), for airtightness best practice, buildings which are mechanically or naturally ventilated should achieve an air permeability of less than 3m³/hr/m², this is quite a high level of airtightness. However the highest level of airtightness required in buildings can be as low as less than 0.6m³/hr/m², which is required in the PassivHaus Standard, which are mechanically ventilated.

As airtightness is a central part to low energy construction, it must be a priority to achieve best practice airtightness when we build, extend or renovate our buildings.

Why is windtightness important?

To achieve maximum thermal efficiency the insulation must be completely sealed on both sides. Figure 9 shows an insulated rafter space with a windtight sealed vapour diffusion open membrane (e.g. a windtight layer) on the outside and an airtight layer (e.g. a sealed Intelligent vapour check) on the inside. The insulation is protected against the elements on the outside by the SOLITEX PLUS membrane and against the penetration of indoor air and vapour on the inside by the airtight seal (e.g. vapour check) in this case INTELLO PLUS. The construction is now windtight externally and airtight internally, similar to a wind breaker over a woolly jumper – perfect!

That's why it makes environmental and economical sense to seal tight and ventilate right!

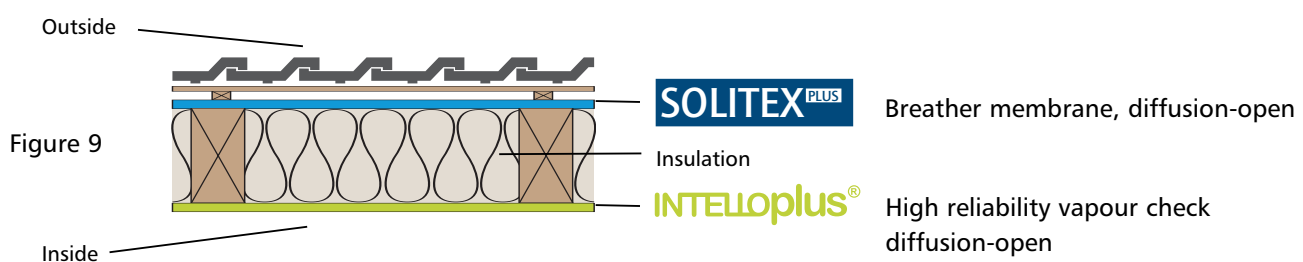

How can I get more advice on how to achieve an airtight building?

On our website www.ecologicalbuildingsystems.com we have an airtight virtual house which shows both block and timber construction. This will help to guide you through sealing details and critical junctions to consider when installing for airtightness. For installers there are various installation demonstration videos of the pro clima Intelligent airtight system on our website www.ecologicalbuildingsystems.com

For architects we have specification details on pro clima prepared by you'll find these under the specification tab under each pro clima product on the website.



We at Ecological, along with your pro clima stockist are always available to help guide you through design detailing, products and advice on installation.

pro clima INTELLO®PLUS Intelligent vapour check features humidity-variable diffusion resistance. It gives maximum protection to thermal insulation where moisture entry may have occurred. This may be through leaks, damp building materials or diffusion through adjoining structural surfaces. INTELLO PLUS possesses the world's best and most effective variable diffusion resistance.

This ensures optimum protection for all fibrous insulating materials in all constructions, whether they are vapour diffusion permeable or vapour diffusion resistant externally such as pitched roofs with bitumen sheeting or metal sheet roofing, flat roofs and walls with a diffusion resistant exterior cladding.

Features

- Provides optimum protection for all thermal insulation systems in roofs, walls and floors.
- Offers high diffusion tightness in winter and maximum diffusion openness in summer.
- In winter, its high diffusion resistance provides ideal protection for the building's structure against condensation.
- In summer, its low diffusion resistance facilitates rapid drying.
- It is translucent, easy to install, fully recyclable.
- It offers the ideal solution to structures that are difficult to protect against condensation e.g. flat roofs, flexible metal sheeting, etc.
- INTELLO PLUS provides lasting protection from mould growth, which protects the health of the occupants and structural durability.
- Meets with the durability requirements of EN 13984.
- Has a very high nail tear resistance due to reinforcing layer.



For sealing solutions we recommend:

ORCON F or pg 10
TESCON No.1 or pg 11
UNI TAPE pg 11



► **TIP** In roof refurbishment pro clima supply the airtightness and Intelligent vapour check INTESANA, contact us for further details.

pro clima INTELLO PLUS

Intelligent vapour check
and airtight membrane



Technical Details

Material/s:	Membrane: polyethylene copolymer; Fleece and reinforcement layer: polypropylene
Vapour resistance: (humidity variable)	< 1.28 MNs/g > 51 MNs/g
Fire Rating:	E
Temperature Resistance:	-40°C to 80°C
3rd party accreditation:	 
Colour:	White
Roll Width:	1.5 metres
Roll Length:	20 metres and 50 metres
Usage:	Interior only

The principal raw material used to produce pro clima DB+ is recycled paper which is strengthened with a reinforcement layer. DB+ is an environmentally friendly option for the sustainable house builder.

Features

- pro clima DB+ is a paper based humidity variable INTELLIGENT vapour check which possesses effective variable diffusion resistance properties.
- pro clima DB+ is an internal, airtight vapour check with humidity variable vapour resistance. It is manufactured from cellulose fibre, reinforced for additional strength and treated with natural salts against fire.
- pro clima DB+ cellulose humidity variable vapour check provides a consistent internal airtight seal for the construction, while reducing the risk of interstitial condensation in both summer and winter conditions. In summer conditions pro clima DB+ allows more vapour diffusion, therefore structural components can rapidly dry out. In winter conditions it permits less vapour diffusion, ensuring the building remains protected against vapour penetration, hence protecting the building fabric from harmful moisture.
- In non-breathing structures (i.e. those with vapour impermeable materials installed externally), any moisture that penetrates the insulation may become trapped and immediately begin to degrade its performance. DB+ eliminates this risk by allowing any trapped moisture to evaporate on a seasonal basis, due to its humidity variable vapour resistance.
- pro clima DB+ Meets with the durability requirements of EN 13984.



For sealing solutions we recommend:

- ECO COLL or pg 10
- ORCON F or pg 10
- UNI TAPE or pg 11
- TESCON No.1 pg 11

pro clima DB+

Intelligent vapour check and airtight membrane

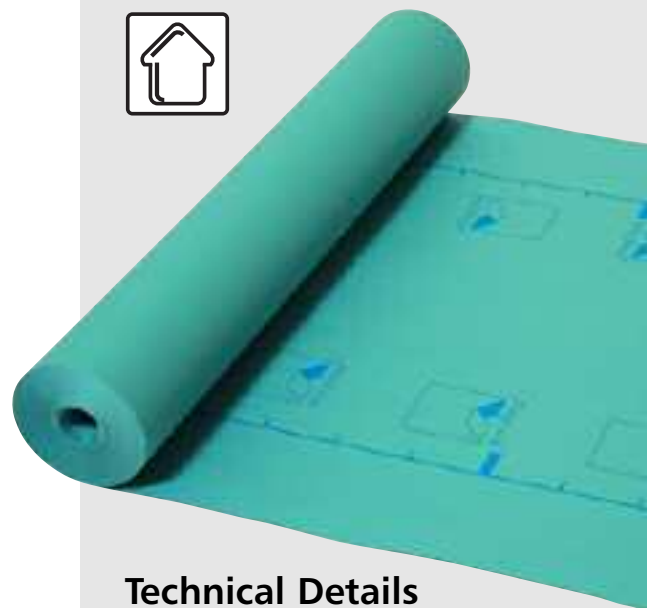

Technical Details

Material/s:	Recycled paper, paper, halogen and plasticiser-free PE film
Vapour diffusion:	< 3.06 MNs/g to > 20.4 MNs/g
Fire Rating:	E
Temperature Resistance:	-40°C to 40°C
3rd party accreditation:	 
Colour:	Blue
Roll Width:	1.35 metres
Roll Length:	50 metres
Recycled content to ISO 14021:	Recycled paper
Usage:	Interior only

ORCON F has exceptionally high adhesion properties while also being elastic. Its outstanding adhesion to building materials gives the joint the necessary safety and longevity. It is suitable for bonding all of the pro clima vapour checks and air-proofing membranes, PE/PA/PP and aluminium foils to other building materials regardless of smooth, rough or smooth stony surface. Unstable or crumbling surfaces either need to be removed or sanded and stabilised using Tescon Primer RP. An easy press extrusion gun is available with 600ml refill tubes. Please contact for further details.

Features

- High strength on building material substrates.
- Airtight bonding in accordance with DIN 4108-7, SIA 180 and ÖNorm B8110-2.
- Airtight outdoor joints, e.g. vapour check for external roof insulation or sub-and-top refurbishment vapour check for re-roofing.
- Wind-proof bonding of roof underlay and facade membranes.
- Greater resistance to high humidity on site.

Technical Details

Material/s:	Non-ageing acrylate polymers, water and denatured alcohol (15%) as solvents.	Life expectancy:	60 years +
Temperature Resistance:	-20°C to 80°C	Usage:	Interior and Exterior
Cartridge Size:	310 ml – sufficient for approximately 5 – 10 metres. 600 ml refill tubes also available.	3rd party accreditation:	

ECO COLL is a natural glue adhesive used in conjunction with DB+ to create a 'natural' airtightness layer. **This product is solely for use with DB+ and should not be used with INTELLO or INTELLO PLUS.**

Features

- Airtight jointing of vapour barriers made from building paper to each other and to adjoining construction elements. E.g. DB+
- Vapour barriers and air seals made of building paper together with ECO COLL natural latex glue are the ecological solution for air sealing.

Technical Details

Material/s:	Natural glue made from natural latex, (casein, talc, cellulose, water and tree resin).	Life expectancy:	60 years +
Temperature Resistance:	-10°C to 40°C	Usage:	Interior only
Cartridge Size:	310 ml – sufficient for approximately 5 – 10 metres.	3rd party accreditation:	

▶ **TIP** The pro clima range of glues and tapes is designed to provide the tightest seal – if they are inadvertently stuck to an area they shouldn't be, we do supply **Glumex**, a water based solution to remove the adhesive – please contact Ecological Building Systems or your nearest stockist for further information.

pro clima ORCON F

Multi-purpose flexible
joint adhesive for indoor
and outdoor application



pro clima ECO COLL

A natural glue adhesive
used in conjunction with
DB+



TESCON No.1 is a flexible multi-purpose adhesive tape for airtight bonds indoors and outdoors in accordance with DIN 4108, SIA 180 and ÖNorm B8110-2. **TESCON VANA** tape is also available, similar to TESCO No. 1 but with higher tensile strength, please contact us for further information.

Features

- TESCO No.1 is used to form a secure and permanent seal of overlaps between foil and fleece membranes (Intelligent vapour checks and airtightness membranes, roof underlays and wall membranes) and joints between such membranes and smooth, non-mineral surfaces.
- TESCO No.1 is also suitable for sealing butt joints between wood-based panels such as OSB or MDF sub-roof panels or wood fibre softboards (e.g., Gutex) in combination with TESCO Primer RP.
- Bonds overlaps between sheets of vapour check and joints between wood based panels (such as OSB), also seals service penetrations.
- Offers high protection against piercing in corners due to its high elasticity.
- With release paper.
- Easy to tear by hand.

Technical Details

Material/s:	Acrylate which is free of solvents or softeners.	Life expectancy:	60 years +
Temperature Resistance:	-40°C to 90°C	Usage:	Interior and Exterior
Roll Width:	6 cms	3rd party accreditation:	
Roll Length:	30 metres		

UNI TAPE is a universal paper based adhesive tape for permanent, airtight and secure bonds indoors in accordance with DIN 4108, SIA 180 and ÖNorm B8110-2.

Features

- UNI TAPE is used for airtight bonding of overlaps between sheets of vapour checks and air-proofing membranes made of sheathing paper or foil as well as joints between such membranes and smooth, non mineral surfaces.
- UNI TAPE is also suitable for sealing butt joints between wood-based panels such as OSB.
- Tears easily. ▪ Quick release paper. ▪ For internal use only.
- The UNI TAPE PATCH comes in 180 x 180 mm pre-cut patches for sealing injection holes indoors, or large perforations.

Technical Details

Material/s:	Acrylate which is free of solvents or softeners.	Life expectancy:	60 years +
Temperature Resistance:	-40°C to 90°C	Usage:	Interior only
Roll Width:	6 cms	3rd party accreditation:	
Roll Length:	30 metres		

▶ **TIP** pro clima tapes are supplied with pro clima PRESSFIX to ensure an immediate seal is achieved.

pro clima TESCON No. 1

Flexible multi-purpose
adhesive tape for
airtight bonds



pro clima UNI TAPE & Patches

Universal adhesive tape
for airtight bonds
indoors



The airtightness of angled joints is important. Sealing is simplified with the corner adhesive tape **TESCON PROFIL**. It features two or three release paper strips. This allows you to "activate" a single part of the adhesive surface and to seal corners junction by junction.

Features

- Suitable for sealing reveals at windows, doors, planed timber, corners and roof windows to the Intelligent airtight vapour check.
- Ensures high protection against piercing in corners due to its high elasticity.



Technical Details

Material/s: Acrylate which is free of solvents or softeners.

Temperature Resistance: -40°C to 90°C

Roll Width: 6 cms

Roll Length: 30 metres

Life expectancy: 60 years +

Usage: Interior and Exterior



TESCON INVIS is a black un-branded tape which is excellent for concealing taped joints on pro clima **SOLITEX WA** wall lining membranes behind open jointed back ventilated facades. It can also be used for sealing butt joints between wood-based panels such as OSB or softwood fibre panels.

Features

- Multi-purpose adhesive tape for inside and outside.
- Windproof and watertight bonds of sub roofs and facade sheeting.
- Airtight bonds in accordance with DIN 4108-7, SIA 180 and ÖNorm B8110-2
- Durable leak-proof bonding, inside and out.
- With a soft fleece backing.

Technical Details

Material/s: Pure acrylate, waterproof, non-ageing and free of solvents or softeners.

Temperature Resistance: -40°C to +90°C

Roll Width: 6 cms

Roll Length: 30 metres

Life expectancy: 60 years +

Usage: Interior and Exterior

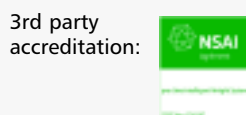

▶ **TIP** Excellent for concealing taped joints on pro clima **SOLITEX WA** wall lining membranes behind back ventilated open jointed facades.

pro clima TESCON PROFIL

Flexible multi-purpose corner tape for windows, doors and corner joints



pro clima TESCON INVIS

Black multi-purpose sealing tape



DUPLEX is a double sided airtight and moisture resistant sealing tape.

Features

- Suitable for fixing all pro clima vapour checks and airtight membranes, PE/PA/PP and aluminium foils to metal studs.
- Suitable for windtight and moisture proof sealing of external membranes.
- For affixing membrane to metal sections in dry construction.
- For rain-proof taping of roof underlay (e.g., SOLITEX PLUS).
- Quick and easy to apply using the Duplex hand dispenser.
- With release foil.
- Sealing membrane to membrane.

We recommend purchasing a hand held dispenser with DUPLEX tape.

Technical Details

Material/s:	Acrylate which is free of solvents or softeners	Life expectancy:	60 years +
Temperature Resistance:	-40°C to 90°C	Usage:	Interior and Exterior
Roll Width:	2.5 cms	3rd party accreditation:	
Roll Length:	20 metres		

▶ **TIP** Ensure all bonding surfaces are grease and dust free to ensure a reliable seal is maintained.

TESCON NAIDEC is a durable airtight sealing double-sided butyl rubber tape for sealing around nail and screw penetrations making it almost impossible for water to seep in; penetrating deep into the pores of membranes and fibreboards, providing durable sealing around nail holes.

Features

- Nail sealing tape on the underside of a lath on inclined roofs to form a durable seal around nail or screw holes.
- Very good sealing action – penetrates deep into the structure.
- Water resistant.
- Extra-strong due to a reinforcing layer.
- Contains no bitumen.

Technical Details

Material/s:	Non-ageing, bitumen-free butyl rubber.	Life expectancy:	60 years +
Temperature Resistance:	-20°C to +80°C	Usage:	Exterior
Roll Width:	5 cms	3rd party accreditation:	
Roll Length:	20 metres		

▶ **TIP** To form a durable seal around nail holes position the NAIDEC centrally on the counter batten – firmly secure using a pro clima PRESSFIX



pro clima DUPLEX

A double sided airtight
and moisture resistant
sealing tape



pro clima TESCON NAIDEC

Double sided butyl
rubber tape



CONTEGA FC is a vapour resistant plaster sealing tape. It forms a high quality bond between window frames and masonry reveals. The airtight bond is completed once the light blue PET fleece is plastered into place. **CONTEGA SL** is also available, with a two-layer PET fleece it gives high flexibility and is available in 30 metre rolls with two widths of 85 mm and 120 mm, for both plastering applications and sealing to membrane.

Features

- CONTEGA FC is a three-layer PET fleece and can be simply bedded in bonding plaster.
- Simple and secure connection to the joints of doors and windows.
- RAL-compliant joint.
- Airtight joint between visible timber components (i.e. OSB) and adjoining structural elements such as brickwork and concrete.

Technical Details

Material/s:	3 layer PET fleece/CONTEGA FC 2 layer PET fleece/CONTEGA SL with acrylate glue which is free of solvents or softeners.	Roll Length:	CONTEGA FC 15 metres CONTEGA SL 30 metres
Temperature Resistance:	-40°C to 90°C	Life expectancy:	60 years +
Roll Width:	CONTEGA FC 8.5 cms CONTEGA SL 8.5 and 12 cm	Usage:	Interior only
		3rd party accreditation:	

► **TIP** Use in conjunction with CONTEGA EXO – the exterior Window and Door Windproof diffusion open sealing tape.

CONTEGA PV forms a high quality bond between vapour check, wood based panels (e.g. OSB) and masonry. The airtight bond is completed once the light blue PET fleece is plastered into place. The latex reinforced layer increases the strength of the adjoining plaster work.



► **TIP** For best bonding results we recommend a gypsum bonding plaster.

Technical Details

Material/s:	3 layered PET fleece with reinforcement mesh and acrylate glue which is free of solvents or softeners.	Life expectancy:	60 years +
Temperature Resistance:	-40°C to 90°C	Usage:	Interior only
Roll Width:	20 cms	3rd party accreditation:	
Roll Length:	15 metres		

pro clima CONTEGA FC & CONTEGA SL

Vapour resistant window
plaster sealing tape



pro clima CONTEGA PV

Vapour resistant masonry
junctions plaster sealing
tape



CONTEGA EXO is an exterior diffusion open windproof sealing tape for windtightly sealing the joints of windows or doors and structural elements. In combination with CONTEGA FC or CONTEGA SL it is also suitable for sealing joints between masonry and timber constructions. A permanent bond is achieved on all pro clima roof and wall membranes, planed and painted wood, high density plastic, metal or hardboard.

Features

- Vapour permeable sealing of external window and door joints.
- Monolithic TEEE functional membrane – active moisture transport.
- RAL compliant in combination with CONTEGA FC/SL indoors.
- Can be plastered over on the fleece side.
- With three adhesive tapes it is very versatile in timber and masonry construction.

Technical Details

Material/s: Double-layer specialist membrane made from PP fleece and TEEE functional film. Integrated adhesive tape is made from pure acrylate, that is waterproof and non-ageing and free of solvents or softeners.

Temperature Resistance: -40°C to +90°C

Roll Width: 85mm and 120mm

Roll Length: 30 metres

Life expectancy: 60 years +

Usage: Exterior only

3rd party accreditation: 

▶ **TIP** we recommend Orcon F for overlapping ends of the tape and for masonry adhesion.

pro clima **INSTAABOX** is used for the airtight installation of service boxes, without a service void on the interior of external walls. It is designed for making airtight connections on vapour check and airtightness layers indoors, for example; pro clima **INTELLO PLUS**, **DB+** and wood-based panels such as **OSB**.

Features

- Installation box for creating space for junction boxes, etc., in buildings without a service void behind the dry lining.
- Meets the requirements of DIN 4108-7, SIA 180 and Ö Norm
- B8110-2 with regard to airtightness for the use of standard service boxes.
- Can be used on both interior and exterior walls and all common substrates used in construction.
- For up to 3 junction boxes.
- Pre-punched exit points for cables.
- For cables up to 20mm in diameter.

For sealing solutions we recommend:

TESCON No.1 pg 11

Technical Details

Material/s: Flexible polyethylene

Temperature Resistance: -10°C to +80°C

Depth: 55mm

Life expectancy: 60 years +

Usage: Interior

3rd party accreditation: 

▶ **TIP** Use a nail or ballpoint pen to make the cable penetration through the perforated position on the INSTAABOX.

pro clima CONTEGA EXO

Exterior Window and
door windproof
sealing tape



pro clima INSTAABOX

Airtight installation of
service boxes



If pipes or cables penetrate the airtightness layer, they too must be securely sealed. The most suitable means of doing this is with airtightness grommets made from EPDM. This flexible material allows a tight flexible fit, and ROFLEX is available in all common diameters. ROFLEX grommets should be sealed to INTELLO PLUS with TESCON No. 1.

Technical Details

Material/s:	EPDM	Life expectancy:	60 years +
Temperature Resistance:	-40°C to + 120°C	Usage:	Interior and Exterior ROFLEX 20 tape should be covered with TESCON No.1 for external use)
Grommet Sizes:	ROFLEX 20 15 – 30 mm – 145 mm x 145 mm	3rd party accreditation:	
	ROFLEX 50 50 – 90 mm – 140 mm x 140 mm		
	ROFLEX 100 100 – 120 mm – 200 mm x 200 mm		
	ROFLEX 150 120 – 170 mm – 250 mm x 250 mm		
	ROFLEX 200 170 – 220 mm – 300 x 300 mm		
		For sealing solutions we recommend: TESCON No.1 pg 11	

If pipes or cables penetrate the airtightness layer, they too must be securely sealed. The most suitable means of doing this is with airtightness grommets made from EPDM. This flexible material allows a tight fit, and KAFLEX allows for a secure feed-through for cables and pipes. KAFLEX cable grommets feature an integrated adhesive with a release paper for ease of application.

Features

- For an airtight seal around pipes and cables which pass through the Intello Plus or DB+ membrane. They are made of non-ageing elastic EPDM rubber in a high adhesive square.
- With release paper.
- Offers high protection against piercing due to its high elasticity.

Technical Details

Material/s:	EPDM acrylate solvent-free adhesive tape	Life expectancy:	60 years +
Temperature Resistance:	-40°C to +100°C	Usage:	Interior only
Grommet Sizes:	KAFLEX Mono Single Cable 6 – 12 mm – 145 mm x 145 mm	3rd party accreditation:	
	KAFLEX Duo Twin Cable 6 – 12 mm – 145 mm x 145 mm		
	KAFLEX Multi - up to 16 cables 6 – 12 mm – 140 mm x 140 mm		

pro clima ROFLEX

Airtightness grommet
for pipework



pro clima KAFLEX

Airtightness grommet
for cables and small pipes

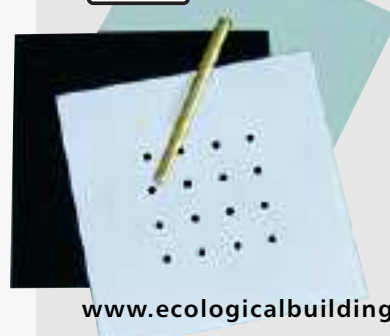

DA-S is an airtight sealing strip for airtight bonds between building components such as wall to floor junctions.

Features

- For airtight connections between roof slopes and wall to floor connections.
- pro clima DA-S strips are glued to building substrates to maintain airtightness continuity at critical junctions, for example floor connections at concrete ceilings, on plywood, chipboard sheets or even for sealing large gaps at window reveals in accordance with regulations by DIN 4108, SIA 180 and ÖNorm B8110-2.
- It is also more resistant to site conditions compared to conventional vapour checks.
- It also functions as a vapour check and airtight sealing layer and is generally applied on the interior side of the insulation layer.



► **TIP** The double dispensing adaptor allows installers to apply 2 beads of ORCON F to concrete or OSB panels in one sequence.

For sealing solutions we recommend:

ORCON F pg 10
TESCON No.1 pg 11

pro clima DA-S

Vapour check and airtight sealing strip manufactured from PP with a robust Polypropylene Protection Fleece



Technical Details

Material/s:	2 layered polypropylene fleece, polypropylene film (halogen free).
Temperature Resistance:	-40°C to 90°C
Fire Rating:	E
Roll Width:	21 cms
Roll Length:	100 metres
3rd party accreditation:	Meets DIN EN 13984
	 
Life expectancy:	60 years +
Usage:	Interior only

TESCON Primer RP is a priming coat suitable on wood, wood fibreboards, block structure, roof structure, walls and concrete floors. Tescon Primer RP is recommended for the preparation of the surface for the application of pro clima tapes such as TESCON NO.1, TESCON VANA, and TESCON PROFIL, as well as the adhesive compounds ORCON F and ECO COLL.

For a permanent connection the surface should be smooth, dry and stable.

Surfaces should be cleaned from any loose materials, dust or sawdust (broom clean). Application of Tescon Primer RP is not possible on frozen surfaces. Surface must be suitable for priming. Concrete, sand and cement or skimmed surfaces must be fully cured and dried before Tescon Primer RP can be applied.

Features

- No drying required – Bonds even on wet surfaces.
- Deep penetration into substrate.
- Strengthens the substrate.
- Solvent free.
- Suitable with all pro clima tapes.



► **TIP** Shake bottle well before application. For speedy application no drying of primer is required, bonding to wet primer is possible using Tescon No1 or Tescon Vana.



► **TIP** TESCON VANA 150mm wide tape is ideal for wood fibreboard applications.

pro clima Tescon Primer RP

Priming coat suitable for
wood fibreboards



Technical Details

Material:	Acryl-Copolymer
Temperature Resistance:	-40°C to 90°C
Storage:	Frost-free, shelf life 24 months
Dissolvent:	Water
Dispenser:	750 ml bottle
Coverage:	approx. 7.5 square metres (depending upon porosity of the surface)
Dispenser:	1000 ml bottle
Coverage:	10 square m
Dispenser:	2500 ml bottle
Coverage:	25 square m

3rd party accreditation:



The **pro clima WINCON** airtightness quality control unit is a high powered fan designed to pinpoint air leakage on site. It empowers the installer to verify if the airtightness work carried out on site after application is to a high standard. Often referred to as the spirit level for airtightness, it is a high performance, easy to use unit.

Features

- Its operation is based on a simple principle: the **pro clima WINCON** generates a negative pressure and thereby enables air leaks to be identified and effectively sealed, prior to the application of the internal lining.
- The **pro clima WINCON** can be installed in an external window or door of the building.
- The **pro clima WINCON** is an innovative device which consists of a high powered fan, a fan controller and a magnehelic pressure gauge, all mounted on one singular wooden frame.
- This device is packaged in a convenient, robust wooden box, complete with smoke puffers for detecting leakages in the building envelope and temporary sealing tapes.
- The magnehelic gauge allows the operator to depressurise the building to up to 60 Pascals.
- Quality control ensures attention to detail during installation.
- The **pro clima Wincon** does not replace the Blower Door test but it compliments the airtightness testing process.



► **TIP** Carry out intermediate airtightness quality check using the WINCON prior to the application of the internal lining.



► **TIP** Ask about our Wizard Vapour Airflow Indicator / Smoke gun to easily detect air leakage when using the Wincon or Blower Door test.

pro clima Wincon airtightness quality control unit

An exceptionally high performance quality control device (9600m³/h at 50 Pa pressure differential)



Technical Details

Units available: 220V and 110V

3rd party accreditation:





1 INITIAL SITUATION

Insulation is installed between the rafters. Semi-rigid batt insulation material is being used in this case. For optimum insulation performance it is important to ensure that there are no gaps between the insulation batts and the supporting rafters.

Outside the insulation, an insulation protection layer (e.g., SOLITEX PLUS, wood fibreboard or roof lining on wooden planking) should be attached to the rafters to provide wind-proofing. It ensures that cold air does not pass through the thermal insulation and gives optimum insulation.

During colder months, the vapour check and airtightness layer must be fitted and secured immediately after installation of the thermal insulation.

Note on blown insulation: The insulation material should be inserted directly after completion of the airtightness layer with INTELLO PLUS.

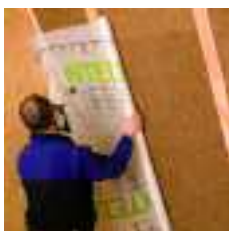

2 FIXING THE MEMBRANES

The INTELLO PLUS vapour check and airtightness membrane is laid on the interior, beneath the insulation. Bonding with adhesive tapes should be on the smooth printed side. Staples should be at least 10 mm wide and 8 mm long and set at a maximum distance of 10-15 cm.

INTELLO PLUS can be unrolled and stapled either lengthwise or crosswise to the rafters. It should be laid as far as possible without creasing.

The lengthwise technique is shown here. With this technique there is usually less waste. For sealing later it is important to extend the vapour check approximately 3 cm onto the gable wall or jamb wall and fasten if possible using staples. This joint is sealed air tightly later.



Note on blown insulation: The maximum staple spacing is then 5 – 10 cm.

3 OVERLAP THE MEMBRANES

Once the first membrane is in place the second layer is fitted. The membrane may overlap by about 10 cm. The printed markings are an aid to orientation.



4 PREPARATION

Surfaces should be brushed down before bonding. Dust should be vacuum cleaned or wiped with a cloth.

All surfaces must be suitable for permanent, airtight adhesion with airtightness tape and joint adhesive, and must be stable, dry, smooth and free of dust, silicone and grease.

Adhesion to frozen surfaces is not possible.

When it comes to protecting the structure, the best results can be achieved with high-quality vapour checks and airtightness membranes and timber derived sheathing. In case of doubt, adhesion tests should be carried out.



5 SEAL

Once the vapour check is fitted it has to be sealed. The membranes should be sealed at overlaps without strain or loading, using TESCON No. 1, TESCON VANA or UNI TAPE. Creases in the overlap area must not be over-taped; they must be cut off and re-sealed. The tape should be applied centrally and pressed down firmly using, for example pro clima PRESSFIX.



6 JAMB WALL

Just as important as the sealing of overlaps are joints to adjacent structural components. TESCON No.1, TESCON VANA or UNI TAPE is used for joints to smooth, non-mineral structural components (such as this jamb wall made of OSB panels). Gable walls are treated similarly.

The joint adhesive ORCON F is applied to adjacent mineral structural components or rough wooden components (e.g., plastered walls or rough timber) with a continuous bead of approximately 5 mm thick ORCON F.

With rough surfaces, increase the bead size as required. Glue the vapour check, with an expansion joint, to the adhesive bead. To allow for movement, do not press the glue completely flat. Pressure laths are usually not required on stable surfaces.



7 GABLE (plastered)

For joints to plastered gable walls, a continuous bead of approximately 5 mm thick ORCON F multi-purpose joint adhesive should be applied from the cartridge. With rough surfaces, increase the bead size as required.

Glue the vapour check and include an expansion joint. Adhere to adhesive bead.



To allow for movement of the parts, do not press the glue completely flat. Pressure laths are usually not required on stable surfaces.

GABLE (unplastered)

For masonry which has yet to be plastered, the plaster sealing tape CONTEGA PV gives a secure, airtight transition. The tape is first attached to the smooth side of the vapour check using its self-adhesive strips.

The white airtight fleece with the integrated blue plaster reinforcement mesh is then pushed back and fixed as far as possible into the corner, using a few dabs of ORCON F adhesive on the masonry.

If the wall is subsequently plastered, then CONTEGA PV should be embedded in the middle layer of the plaster. To do this, push back the fleece and reinforcement, apply plaster to the wall behind CONTEGA PV, lay the fleece and reinforcement in the fresh layer of plaster and then complete the plaster work. Plasters containing



TIP See our website for Airtight Installation Video.
www.ecologicalbuildingsystems.com



gypsum have a sufficient adhesive strength. With cement, chalk or loam plasters, please use a reinforcement layer.



8 ROOF BEAM - Purlin

ORCON F joint adhesive is used at rough timber, rafters, purlins or other roof timbers. Apply ORCON F in an approximately 5 mm thick adhesive bead. With rough surfaces, increase the bead size as required.



Lay the vapour check (if possible) with an expansion joint in the adhesive bead. Do not press the adhesive completely flat.



9 CHIMNEY

For connections to insulated, double-layer chimneys, apply approximately 3 cm of INTELLO to the chimney. Apply an approximately 5 mm thick adhesive bead (more if necessary) with ORCON F and lay the membrane, with an expansion joint, in the adhesive bed. Do not press the adhesive completely flat.



Seal the corners with short pieces of TESCON No. 1. In the centre of the adhesive tape, cut halfway through. Then it is easy to shape.



10 PIPE AND CABLE

If pipes or cables penetrate the airtightness layer they too must be securely sealed. The most suitable means of doing this is with airtightness grommets made from EPDM. This flexible material allows a tight fit, and KAFLEX is available in all common diameters.

Cable grommets are self-adhesive. Remove the release paper, push over the cable and stick on. ROFLEX pipe grommets are affixed using TESCON No.1. Press firmly to secure the adhesive tape.



11 CORNER SEALING

The airtightness of angled joints is also important. Sealing is simplified with the corner adhesive tape TESCON PROFIL. It features three release foil strips. This allows you to "activate" a single part of the adhesive surface and to seal corners junction by junction.



In the second step, simply remove the rest of the release foil and finish sealing.



12 COMPLETION

Cross-battens with a maximum spacing of 50 cm should hold the weight of the insulation. An interior lining protects the membranes from damage and UV light.

Once all the joints have been sealed, it is advisable to check the airtightness using a BLOWER DOOR or a pro clima WINCON test unit.



pro clima INTELLO PLUS

Application Guide

APPLICATION

pro clima high-performance system for creating secure vapour check and airtightness layers according to DIN 4108, SIA 180, ÖNorm B8110-2, and to UK and Ireland T.G.D. Part L Airtightness Requirements. Perfect protection for thermal insulation against structural damage and mould. This extremely high level of security is achieved by the humidity-variable diffusion resistance of the membrane – even in structurally challenging buildings.

ADVANTAGES

- ✓ Outstanding protection against structural damage and mould.
- ✓ For pitched roofs, flat roofs, walls, ceilings and floors.
- ✓ Easy to apply, no splicing or tear propagation.
- ✓ Complete airtightness system with all necessary adhesive agents.

TERMS AND CONDITIONS

The joints must not be systematically or intentionally subjected to strain. When the vapour check membrane is sealed, the weight of the insulating material must be borne by the lathing. Adhesion should be supported by battens if necessary. Press firmly to secure the adhesive tape. Ensure there is sufficient back pressure. Airtight seals can only be achieved on vapour check membranes that have been laid without folds or creases. Ventilate the interior space regularly to prevent build-up of excessive humidity. Use a dryer if necessary. The information provided here is based on practical experience and the current state of knowledge. We reserve the right to make changes to the recommendations given or to make alterations due to technical improvements in the quality of our products. We would be happy to inform you of the current state of the art at the time you use our products.

► **TIP** With blown insulation materials or insulation materials that are prone to sagging, an additional supporting lath should be placed on the connections between the membrane overlaps.

SOLITEX PLUS is the Next Generation of High Performance vapour permeable Underlay. With an impressive range of characteristics such as high Vapour Permeability, Extreme Watertightness, High Nail Tear Resistance and Thermostability, SOLITEX PLUS offers superior protection against condensation risk and extreme resistance against pelting rain. SOLITEX PLUS, from pro clima is a Diffusion-Open vapour permeable membrane.

SOLITEX PLUS contains a monolithic membrane which employs Closed Cell Technology compared to conventional microporous membranes. Closed cell membranes offer superior weather tightness, and at the same time ensure that a significant amount of water vapour is actively removed from the inside of the building structure and diffused to the exterior. The combination of these two properties is the determining factor when it comes to quality and the safety of the roof construction.

Detailed installation instructions are available on request.

Features

- Totally resistant to all wood preservatives, wood treatments or natural wood resins.
- Extreme resistance to wind driven pelting rain.
- Totally resistant to contamination due to on site chemicals.
- Extremely Nail-Tear resistant >350N.
- Extremely Water-Tight >2500mm.
- High physical strength.
- High vapour permeability.
- Four ply layer.
- Resistant to ageing.
- Lightweight for ease of handling.

For sealing solutions we recommend:

TESCON No.1	pg 11
TESCON PROFIL	pg 12
DUPLEX	pg 13
TESCON NAIDEC	pg 13



Windtight Exterior Products

pro clima SOLITEX PLUS

Vapour permeable roof underlay



Technical Details

Material/s: Spunbonded 4 reinforced layer polypropylene membrane with TEEE monolithic central membrane

Water Vapour Resistance: < 0.15 MNs/g

Water Resistance: > 2.5m

Nail Tear Resistance: > 350N

Fire Rating: E

Temperature Resistance: -40°C to +100°C

3rd party accreditation:



3rd party product endorsement: NHBC Standards 2007

Colour: Blue

Roll Width: 1.5 metres (smaller rolls available for window and floor connections)

Roll Length: 50 metres (smaller rolls available for window and floor connections)

Usage: Exterior only

www.ecologicalbuildingsystems.com

pro clima SOLITEX membranes have an impressive range of basic characteristics: diffusion-permeable, rainproof, highly tear-resistant. Quick and safe to work with.

Cover fleece

The robust polypropylene micro-fibre cover fleece is water - resistant and provides optimum protection against the penetration of damp. It protects the specialist film below from damage and UV radiation.

The honeycomb structure guarantees non-slip properties even when wet. It is coloured blue to prevent dazzling when it is being laid.

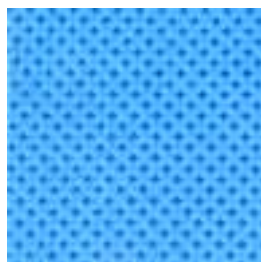

Specialist film

A stretchable, diffusion permeable specialist film gives the pro clima SOLITEX membranes extremely high resistance to water. At the same time, vapour can pass through it almost unrestricted.

In addition, the specific properties of the specialist film ensure the excellent wind resistance properties of the pro clima SOLITEX membranes.



Reinforcement material

The tightly meshed polypropylene reinforcement material doubles the overall strength of the SOLITEX PLUS membrane. If it is used as a sarking membrane, the material is highly effective at preventing the membrane being broken by nails or feet.

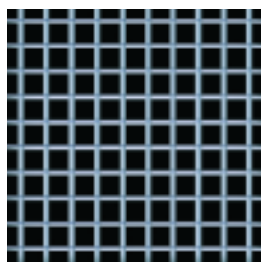

No tent effect

The fact that the pro clima SOLITEX membranes are multilayered prevents the tent effect (tent canvases leak at points of contact).

The pro clima SOLITEX membranes can be supported across the whole surface.

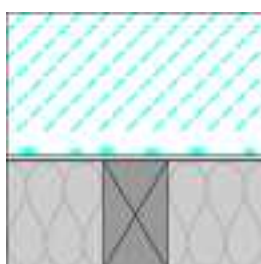

Closed cell technology ensures that dampness can dry more easily and quickly to the outside. This is an advantage both during construction (when the timber may be damp) and during the life of the building.

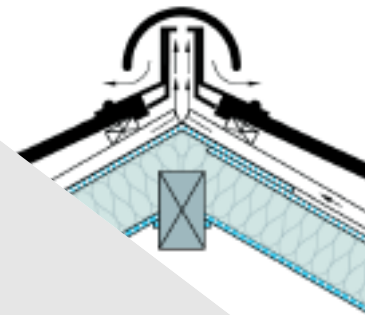
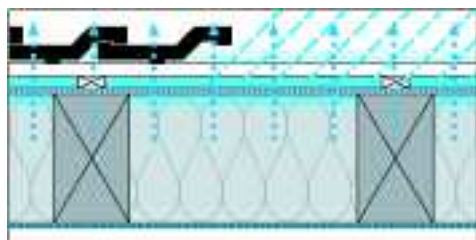

Windtight Exterior Products

pro clima SOLITEX

Sarking, roof lining and wall lining membranes



▶ **TIP** Using TESCON NAIDEC a butyl nail sealing tape on the underside of a batten helps ensure a watertight and windtight seal around nail or screw holes.

▶ **TIP** Glueing the roof lining membrane increases the waterproof and windproof properties of the roof area.

▶ **TIP** Overlap on the membranes should be at least 10cm. A greater overlap is recommended if the roof pitch is less than the regulation amount.

SOLITEX UM connect is for use as a diffusion-open underlay with 3D separation layer and butyl self-adhesive strips. It is suitable for ventilated and unventilated structures in combination with any type of roofing or facade materials such as titanium zinc, aluminium, stainless steel, galvanised steel, copper, etc.

Features

- 3D separation layer – 8mm thick 3D separation layer made of spun-bonded PP fabric ensures constant air circulation of the underside of the sheet metal.
- Provides reliable protection against permanent damp and corrosion.
- The soft layer of spun-bonded fabric provides noticeable sound insulation against rain and hail.
- The high-permeability backing layer includes an intelligent membrane. If necessary, it lowers its moisture variable-diffusion resistance to an mvtr-value of 0.05 MNs/g, ensuring maximum drying of the planking and rafters.
- Integrated butyl rubber self-adhesive strips.

Technical Details

Material/s: Spunbonded 4 ply layer with 3D separation layer with 2 self adhesive zones, polypropylene membrane with TEEE monolithic central membrane, entanglement layer of polypropylene

Water Vapour Resistance: 0.1 MNs/g

Water Resistance: > 2.5m

Nail Tear Resistance: > 130N

Fire Rating: E

Temperature Resistance: -40°C to +100°C

Colour: Light Blue

Roll Width: 1.4 metres

Roll Length: 25 metres

Usage: Exterior only

3rd party accreditation: 

SOLITEX UD connect is for use as a diffusion-open underlay or roof lining membrane on boarding, such as wood fibreboards or insulation materials.

Features

- High wear-resistance micro-fibre fleece.
- Very high resistance to driving rain.
- Very high thermal stability.
- Suitable for use as a temporary roof covering USB-A/UDB-A
- 2 self adhesive zones for rapid wind-proofing from outside.

Technical Details

Material/s: 3 ply membrane with 2 self adhesive zones, polypropylene membrane with TEEE monolithic central membrane

Water Vapour Resistance: 0.1 MNs/g

Water Resistance: > 2.5m

Nail Tear Resistance: > 130N

Fire Rating: E

Temperature Resistance: -40°C to +100°C

Colour: Light Blue

Roll Width: 1.5 metres

Roll Length: 50 metres

Usage: Exterior only

3rd party accreditation: 



pro clima SOLITEX UM connect

4 layer roofing
underlay with 3D
separation
layer

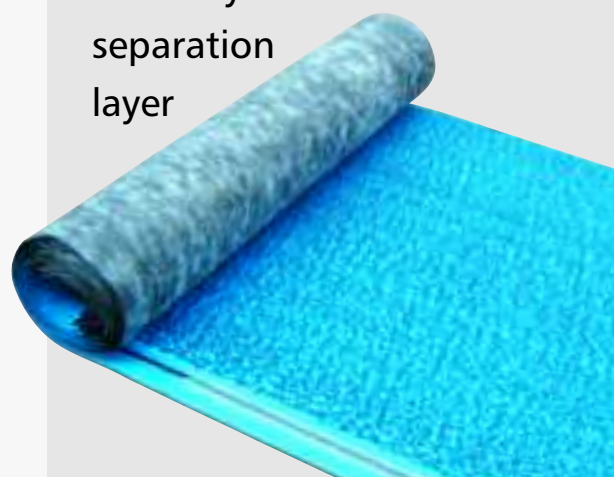

pro clima SOLITEX UD connect

3-ply sarking membrane
and roof lining membrane
with 2 integrated
self-adhesive
strips



pro clima SOLITEX WA is a tough, breathable membrane specifically designed to protect and enhance timber frame structures. It can be applied in the factory to the external face of pre-fabricated wall panels, or on-site to timber frame wall assemblies.

Features

- Spun-bonded high density polypropylene nonwoven micro-fibre fleece.
- Optimum protection for the structure against driving rain, snow and dust during construction.
- Continues to protect the structure against excessive damp and any water ingress that may penetrate the outer cladding.
- Contributes to an overall moisture control solution for timber frame structures.
- Protects exterior sheathing material in a timber frame wall construction from excessive dampness and degradation which may otherwise be caused by water ingress, while at the same time allowing the sheathing material to breathe in order to prevent mould or other fungal growth.
- In locations of extreme exposure overlaps of pro clima SOLITEX WA can be sealed using pro clima TESCON INVIS black tape to conceal taped joints or seal with pro clima DUPLEX double sided tape.
- SOLITEX WA offers high UV stability.
- SOLITEX WA is available in a large range of dimensions and colours and is IAB Certified.
- Black – reduces the risk of visibility through timber cladding.



For sealing solutions we recommend:

TESCON INVIS pg 12
TESCON PROFIL pg 12
DUPLEX pg 13

▶ **TIP** TESCON INVIS is excellent for concealing taped joints on pro clima SOLITEX WA wall lining membranes behind open jointed back ventilated facades.

pro clima 'SOLITEX WA'

Vapour permeable wall lining membrane



Technical Details

Material: 100% polypropylene

Water Vapour Resistance: 0.038 MNs/g

Fire Rating: E

Temperature Resistance: -40°C to +100°C

3rd party accreditation:



Colour: Black - variety of colour available

Roll Width: 1.5 - 3.0 metres

Roll Length: 50 and 100 metres

Usage: Exterior only

Eco Wall

The principle of Eco Wall was developed by Ecological Building Systems as a suggested ecological alternative to conventional methods of timber frame construction.

Eco Wall combines high levels of energy efficiency and safety from potential problems associated with condensation risk, with minimum embodied energy, and high levels of comfort and health, using natural materials with a significantly reduced carbon footprint.

Eco Wall consists of a combination of SASMOX gypsum bonded wood particle board, pro clima DB+ Intelligent cellulose vapour check or pro clima INTELLO PLUS Intelligent Polyethylene co-polymer vapour check, Thermo Hemp natural insulation, and Panelvent natural wood fibre external sheathing.

The products shown in Eco Wall along with other environmentally friendly building products are available from Ecological Building Systems. Don't hesitate to contact our sales staff to discuss the products within the Eco Wall system.



As part of our airtight range we are also delighted to bring you the **Wellhofer** attic hatch which is pre sealed for airtightness. Manufactured and engineered in Germany and has been tested to stringent DIN standards to comply with airtightness and insulation requirements. The **Wellhofer** hatch remains airtight even under blower door test conditions.

Features

- An airtight seal of the door itself is maintained by means of a pre-stressed spring which ensures the door remains airtight, even when a blower door test is carried out.
- The gap between the door and the hatch is sealed with a rubber gasket. This durable seal has been tested against ageing.
- An Airtight sealing system ensures that no air leakage occurs between the gap between ceiling and frame. This is due to the double sided adhesive tape and Insulation strip.
- Includes a pre-insulated layer.



Airtight pre-insulated attic hatch

Pre-sealed for airtightness



Standard Size
(size of ceiling opening in cms)

Length	120
Width	60
Height	25

The finished measurement of the casing is 1.5 cm smaller in length and width than the ceiling.

Attic ladders are available on request. Other sizes are available.

Please contact our sales office for further information or test reports.

Airtightness best practice dictates that surface penetration of the external envelope should be minimised. Downlights present particular challenges for airtight design and continuity of the insulation layer. However, if downlights are present there is a robust solution in the **OPTIME** Downlight housing units.

Designed as an innovative one stop solution for achieving a safe, easy to install sealing system for downlights. Optime Downlight housing boxes are offered as Mini and Maxi housing. The Optime Maxi will accommodate a transformer, the Mini is suitable only to house the downlight. Downlight protector Mini is designed to suit all types of roofs and ceilings as it is very suitable in narrow places. Optime Downlight boxes significantly reduce the carbon footprint of buildings which incorporate downlights as well as improving comfort and minimising problems associated with condensation in cold attics.

While the Optime Downlight housing is made from a non-flammable materials Optime Downlight is not to be relied upon as a fire barrier.

Features

- The Mini is especially made for narrow spacings - 200 x 200 x 140 mm.
- Simple to install.
- Can be used for most conventional timber ceilings.
- Supplied with a 'snap on' airtight cover for housing the light fixing tightly.
- Ensures an effective moisture barrier is maintained.
- For energy conservation we recommend low energy light fittings, however, the housing is suitable for downlights up to 50W.
- Inflammable – will tolerate high temperatures in accordance with building regulations.
- Recognised by Nemko.
- Made from recyclable material.
- It is important that the downlight is positioned at the centre of the box.



It is essential that light fittings are installed as per the Optime fitting manual, contact us for further information.



Optime Maxi



Optime Mini

Optime Downlight Housing

Airtight Flush mounted housing for downlights



Technical Details

The transformer is NOT to be placed within the Downlight protector Mini, since the size of the box causes too high a temperature for the transformer. The transformer should either be mounted externally or by using the Downlight Protector Maxi. Downlight protector Maxi is also available with a flexible mounting as illustrated above.

3rd party accreditation:



Optime Mini size: 200 x 200 x 140

Optime Maxi size: 320 x 320 x 160

Ecological Building Systems Ltd has been at the forefront of environmental and sustainable building product solutions for over a decade, gaining the sole agency in Ireland and the UK for pro clima, the eminent and well established German brand of Intelligent Airtight and Windtight building solutions. Ecological also supply a range of natural insulations and GUTEX wood fibreboards.

The company now distributes the pro clima range through a network of trained stockists, ensuring local supply and superior service. Please telephone or visit our website for your nearest local supplier.

This brochure aims to dispel some of the myths surrounding airtightness and guide you through the full range of pro clima product solutions. However, we also have more technical documents should you require them and our dedicated technical team at Ecological Building Systems are always on hand to offer advice and product solutions for airtightness and windtightness and moisture management.

You can also find full information on our website www.ecologicalbuildingsystems.com



Technical Sales Service and Back Up

Ecological Building Systems is pleased to provide technical advice on how to incorporate pro clima products into different forms of constructions for new build and refurbishment projects.

- We offer a technical sales help-line .
- CPDs and airtight installation training.
- Specification Clauses available for architects from **GreenSpec** on our website.
- Hygro-thermal modelling using WUFI.
- Copies of more in-depth relevant reports and samples.
- Help and advice on meeting the requirements of Building Regulations.
- View our Interactive Airtight House on www.ecologicalbuildingsystems.com for advice on critical airtight junctions for block and timber.
- Airtight Installation Video on our website.
- U Value Calculations and Dew Point Assessments.



Certified



nswcpd

certified

for airtightness

on our website.

on our website.

on our website.

on our website.

on our website.

on our website.

on our website.

on our website.

on our website.

on our website.

on our website.

on our website.

on our website.

on our website.

on our website.

on our website.

on our website.

on our website.

on our website.

on our website.

on our website.

on our website.

on our website.

on our website.

on our website.

on our website.

on our website.

on our website.

on our website.

on our website.

on our website.

on our website.

on our website.



The information provided by Ecological Building Systems Ltd is based on practical experience and the current state of knowledge. We reserve the right to make changes to the recommendations given or to make alterations due to technical developments and associated improvements in the quality of pro clima's products. Advice and recommendations are given in good faith as a general guide and a service to designers, contractors and manufacturers.

Products in this catalogue have been independently certified by the following organisations:



Ecological Building Systems are proud to be members of and associated with the following organisations:



Recycled
Supporting responsible use
of forest resources
www.fsc.org Cert no. TF-COC-1977
© 1996 Forest Stewardship Council



Your local pro clima stockist



For Stockists contact

Ireland

T. +353 (0) 46 9432104

F. +353 (0) 46 9432435

UK

T. +44 (0) 5600 758025

F. +44 (0) 5600 758026

E. info@ecologicalbuildingsystems.com

www.ecologicalbuildingsystems.com